



The information provided in this documentation contains general descriptions and/or technical characteristics of the performance of the products contained herein. This documentation is not intended as a substitute for and is not to be used for determining suitability or reliability of these products for specific user applications. It is the duty of any such user or integrator to perform the appropriate and complete risk analysis, evaluation and testing of the products with respect to the relevant specific application or use thereof. Neither Schneider Electric Industries SAS nor any of its affiliates or subsidiaries shall be responsible or liable for misuse of the information contained herein.



Main

Range of product	Altivar Process ATV600
Product or component type	Variable speed drive
Product specific application	Process and utilities
Device short name	ATV650
Variant	Standard version
Product destination	Synchronous motors Asynchronous motors
EMC filter	Integrated with 150 m conforming to EN/IEC 61800-3 category C3 Integrated with 50 m conforming to EN/IEC 61800-3 category C2
IP degree of protection	IP55 conforming to IEC 60529 IP55 conforming to IEC 61800-5-1
Type of cooling	Forced convection
Supply frequency	50...60 Hz - 5...5 %
Network number of phases	3 phases
[Us] rated supply voltage	380...480 V - 15...10 %
Motor power kW	30 kW (heavy duty) 45 kW (normal duty)
Motor power hp	40 Hp heavy duty 60 hp normal duty
Line current	57.3 A at 480 V (normal duty) 54.8 A at 380 V (heavy duty) 48.3 A at 480 V (heavy duty) 79.8 A at 380 V (normal duty)
Prospective line I _{sc}	50 kA
Apparent power	40.2 kVA at 480 V (heavy duty) 57.4 kVA at 480 V (normal duty)
Continuous output current	59 A at 4 kHz for heavy duty 87 A at 4 kHz for normal duty
Maximum transient current	92.3 A during 60 s (heavy duty) 96.8 A during 60 s (normal duty)
Asynchronous motor control profile	Optimized torque mode Constant torque standard Optimized torque mode
Synchronous motor control profile	Synchronous reluctance motor Permanent magnet motor
Output frequency	0.0001...0.5 kHz
Speed drive output frequency	0.1...599 Hz
Nominal switching frequency	4 kHz
Switching frequency	4...12 kHz with derating factor 2...12 kHz adjustable
Safety function	STO (safe torque off) SIL 3
Discrete input logic	16 preset speeds

Communication port protocol	Ethernet Modbus TCP Modbus TCP
Option card	Slot A: communication module, Profinet Slot A: communication module, DeviceNet Slot A: communication module, Modbus TCP/ EtherNet/IP Slot A: communication module, CANopen daisy chain RJ45 Slot A: communication module, CANopen SUB-D 9 Slot A: communication module, CANopen screw terminals Slot A/slot B: digital and analog I/O extension module Slot A/slot B: output relay extension module Slot A: communication module, Ethernet IP/Modbus TCP/MD-Link Communication module, BACnet MS/TP Communication module, Ethernet Powerlink Slot A: communication module, Profibus DP V1

Complementary

Output voltage	\leq power supply voltage
Permissible temporary current boost	1.5 x I_n during 60 s (heavy duty) 1.1 x I_n during 60 s (normal duty)
Motor slip compensation	Adjustable Automatic whatever the load Can be suppressed Not available in permanent magnet motor law
Acceleration and deceleration ramps	Linear adjustable separately from 0.01...9999 s
Braking to standstill	By DC injection
Protection type	Safe torque off: motor Motor phase break: motor Thermal protection: drive Safe torque off: drive Overheating: drive Overcurrent between output phases and earth: drive Overload of output voltage: drive Short-circuit protection: drive Motor phase break: drive Overvoltages on the DC bus: drive Line supply overvoltage: drive Line supply undervoltage: drive Line supply phase loss: drive Overspeed: drive Break on the control circuit: drive Thermal protection: motor
Frequency resolution	Analog input: 0.012/50 Hz Display unit: 0.1 Hz
Electrical connection	Line side: screw terminal 25...50 mm ² /AWG 4...AWG 1 Motor: screw terminal 35...50 mm ² /AWG 3...AWG 1 Control: removable screw terminals 0.5...1.5 mm ² /AWG 20...AWG 16
Connector type	RJ45 (on the remote graphic terminal) for Modbus serial RJ45 (on the remote graphic terminal) for Ethernet/Modbus TCP
Physical interface	2-wire RS 485 for Modbus serial
Transmission frame	RTU for Modbus serial
Transmission rate	4.8, 9.6, 19.2, 38.4 kbit/s for Modbus serial 10/100 Mbit/s for Ethernet IP/Modbus TCP
Exchange mode	Half duplex, full duplex, autonegotiation Ethernet/Modbus TCP
Data format	8 bits, configurable odd, even or no parity for Modbus serial
Type of polarization	No impedance for Modbus serial
Number of addresses	1...247 for Modbus serial
Method of access	Slave Modbus TCP
Supply	Internal supply for reference potentiometer (1 to 10 kOhm): 10.5 V DC +/- 5 %, <10 mA, protection type: overload and short-circuit protection Internal supply for digital inputs and STO: 24 V DC (21...27 V), <200 mA, protection type: overload and short-circuit protection External supply for digital inputs: 24 V DC (19...30 V), <1.25 mA, protection type: overload and short-circuit protection

Local signalling	3 LEDs (dual colour) for embedded communication status 4 LEDs (dual colour) for communication module status 1 LED (red) for presence of voltage 3 LEDs for local diagnostic
Width	290 mm
Height	910 mm
Depth	340 mm
Net weight	50 kg
Analogue input number	3
Analogue input type	AI1, AI2, AI3 software-configurable current: 0...20 mA/4...20 mA, impedance: 250 Ohm, resolution 12 bits AI1, AI2, AI3 software-configurable voltage: 0...10 V DC, impedance: 30 kOhm, resolution 12 bits
Discrete input number	8
Discrete input type	DI5, DI6 programmable as pulse input: 0...30 kHz, 24 V DC (<= 30 V) STOA, STOB safe torque off, 24 V DC (<= 30 V), impedance: > 2.2 kOhm DI1...DI6 programmable, 24 V DC (<= 30 V), impedance: 3.5 kOhm
Input compatibility	DI5, DI6: discrete input level 1 PLC conforming to IEC 65A-68 STOA, STOB: discrete input level 1 PLC conforming to EN/IEC 61131-2 DI1...DI6: discrete input level 1 PLC conforming to EN/IEC 61131-2
Discrete input logic	Negative logic (sink) (DI1...DI6), > 16 V (state 0), < 10 V (state 1) Positive logic (source) (DI5, DI6), < 0.6 V (state 0), > 2.5 V (state 1) Positive logic (source) (STOA, STOB), < 5 V (state 0), > 11 V (state 1) Positive logic (source) (DI1...DI6), < 5 V (state 0), > 11 V (state 1)
Analogue output number	2
Analogue output type	Software-configurable current AO1, AO2: 0...20 mA, resolution 10 bits Software-configurable voltage AO1, AO2: 0...10 V DC impedance 470 Ohm, resolution 10 bits
Sampling duration	5 Ms +/- 1 ms (DI5, DI6) - discrete input 5 Ms +/- 0.1 ms (AI1, AI2, AI3) - analog input 10 Ms +/- 1 ms (AO1) - analog output 2 ms +/- 0.5 ms (DI1...DI4) - discrete input
Accuracy	+/- 1 % AO1, AO2 for a temperature variation 60 °C analog output +/- 0.6 % AI1, AI2, AI3 for a temperature variation 60 °C analog input
Linearity error	AO1, AO2: +/- 0.2 % for analog output AI1, AI2, AI3: +/- 0.15 % of maximum value for analog input
Relay output number	3
Relay output type	Configurable relay logic R2: sequence relay NO electrical durability 100000 cycles Configurable relay logic R3: sequence relay NO electrical durability 100000 cycles Configurable relay logic R1: fault relay NO/NC electrical durability 100000 cycles
Refresh time	Relay output (R1, R2, R3): 5 ms (+/- 0.5 ms)
Minimum switching current	Relay output R1, R2, R3: 5 mA at 24 V DC
Maximum switching current	Relay output R1, R2, R3 on resistive load, cos phi = 1: 3 A at 30 V DC Relay output R1, R2, R3 on inductive load, cos phi = 0.4 and L/R = 7 ms: 2 A at 250 V AC Relay output R1, R2, R3 on inductive load, cos phi = 0.4 and L/R = 7 ms: 2 A at 30 V DC Relay output R1, R2, R3 on resistive load, cos phi = 1: 3 A at 250 V AC
Isolation	Between power and control terminals
Variable speed drive application selection	Compressor centrifugal Building - HVAC
Motor power range AC-3	30...50 kW at 380...440 V 3 phases
Mounting mode	Wall mount

Environment







Insulation resistance	> 1 MOhm 500 V DC for 1 minute to earth
Noise level	69.7 dB conforming to 86/188/EEC
Operating position	Vertical +/- 10 degree
Maximum THDI	<48 % from 80...100 % of load conforming to IEC 61000-3-12
Electromagnetic compatibility	Radiated radio-frequency electromagnetic field immunity test level 3 conforming to IEC 61000-4-3 Electrical fast transient/burst immunity test level 4 conforming to IEC 61000-4-4 1.2/50 µs - 8/20 µs surge immunity test level 3 conforming to IEC 61000-4-5 Conducted radio-frequency immunity test level 3 conforming to IEC 61000-4-6 Electrostatic discharge immunity test level 3 conforming to IEC 61000-4-2

Pollution degree	2 conforming to EN/IEC 61800-5-1
Vibration resistance	1 gn (f= 13...200 Hz) conforming to IEC 60068-2-6 1.5 mm peak to peak (f= 2...13 Hz) conforming to IEC 60068-2-6
Shock resistance	15 gn for 11 ms conforming to IEC 60068-2-27
Relative humidity	5...95 % without condensation conforming to IEC 60068-2-3
Ambient air temperature for operation	40...50 °C (with derating factor) -15...40 °C (without derating)
Ambient air temperature for storage	-40...70 °C
Operating altitude	1000...4800 m with current derating 1 % per 100 m <= 1000 m without derating
Environmental characteristic	Dust pollution resistance class 3S3 conforming to EN/IEC 60721-3-3 Chemical pollution resistance class 3C3 conforming to EN/IEC 60721-3-3
Standards	EN/IEC 61800-3 Environment 1 category C2 EN/IEC 61800-3 Environment 2 category C3 EN/IEC 61800-3 EN/IEC 61800-5-1 IEC 61000-3-12 IEC 60721-3 IEC 61508 IEC 13849-1 UL 508C
Product certifications	TÜV CSA UL ATEX INERIS REACH Bureau Veritas DNV-GL CSA
Marking	CE

Packing Units

Unit Type of Package 1	PCE
Number of Units in Package 1	1
Package 1 Weight	54 kg
Package 1 Height	43 cm
Package 1 width	64 cm
Package 1 Length	112 cm

Offer Sustainability

Sustainable offer status	Green Premium product
REACH Regulation	 REACH Declaration
EU RoHS Directive	Pro-active compliance (Product out of EU RoHS legal scope)  EU RoHS Declaration
Mercury free	Yes
RoHS exemption information	 Yes
China RoHS Regulation	 China RoHS Declaration
Environmental Disclosure	 Product Environmental Profile
Circularity Profile	 End Of Life Information
WEEE	The product must be disposed on European Union markets following specific waste collection and never end up in rubbish bins
Upgradeability	 Upgraded Components Available

Clearances

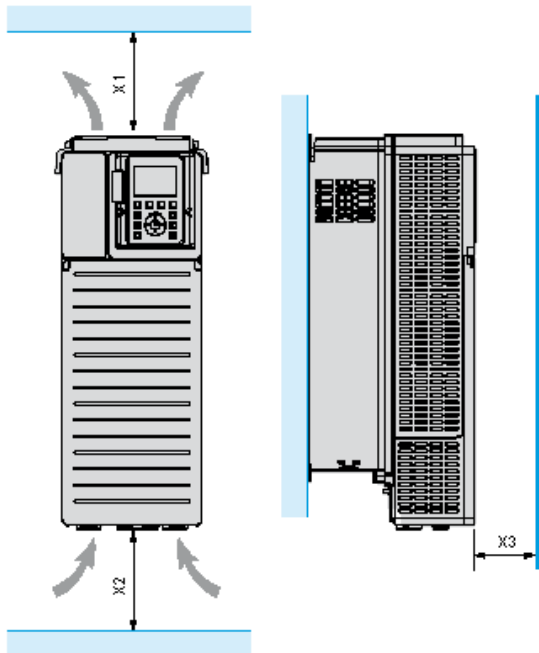

X1	X2	X3
≥ 100 mm (3.94 in.)	≥ 100 mm (3.94 in.)	≥ 10 mm (0.39 in.)

Three-Phase Power Supply with Upstream Breaking via Line Contactor

Connection diagrams conforming to standards EN 954-1 category 1 and IEC/EN 61508 capacity SIL1, stopping category 0 in accordance with standard IEC/EN 60204-1

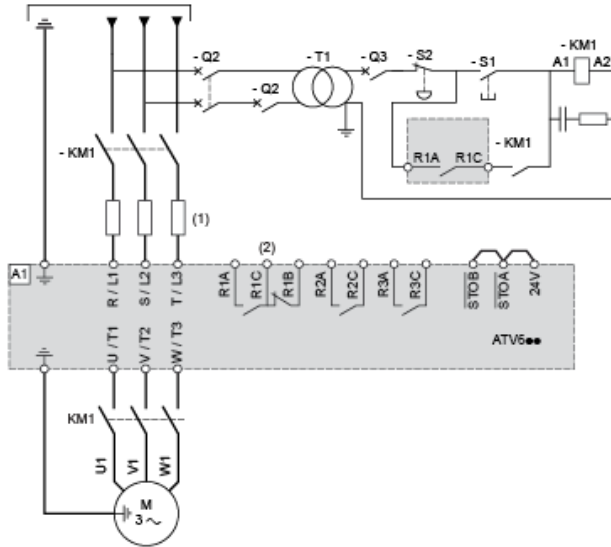

- (1) Line choke if used
- (2) Use relay R1 set to operating state Fault to switch Off the product once an error is detected.
- A1 : Drive
- KM1 :Line Contactor
- Q2, Circuit breakers
- Q3 :
- S1, Pushbuttons
- S2 :
- T1 : Transformer for control part

Three-Phase Power Supply with Downstream Breaking via Contactor

Connection diagrams conforming to standards EN 954-1 category 1 and IEC/EN 61508 capacity SIL1, stopping category 0 in accordance with standard IEC/EN 60204-1

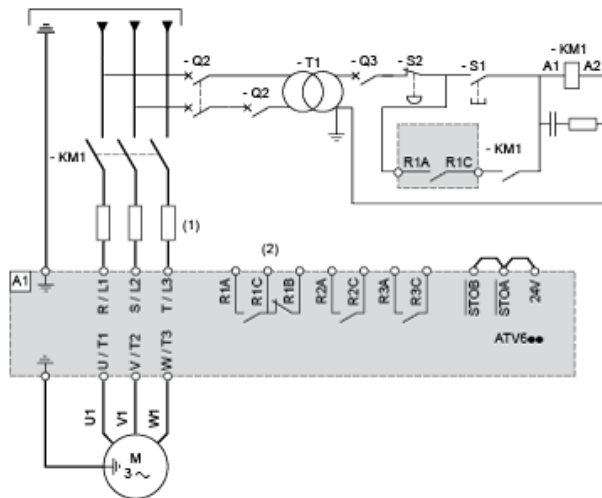

- (1) Line choke if used
- (2) Use relay R1 set to operating state Fault to switch Off the product once an error is detected.
- A1 : Drive
- KM1 :Contactor

Control Block Wiring Diagram

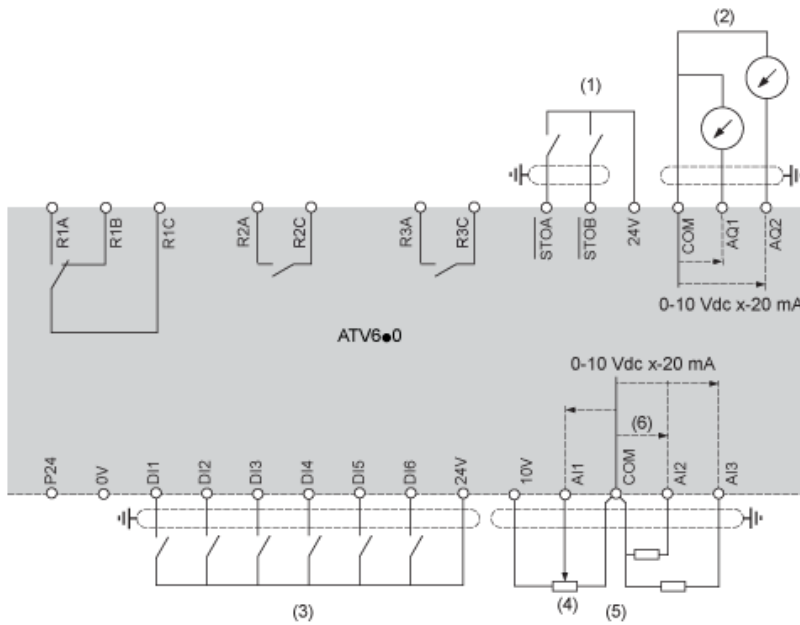

- (1) Safe Torque Off
 - (2) Analog Output
 - (3) Digital Input
 - (4) Reference potentiometer
 - (5) Analog Input
- R1A, Fault relay
R1B,
R1C :
R2A, Sequence relay
R2C :
R3A, Sequence relay
R3C :

Sensor Connection

It is possible to connect either 1 or 3 sensors on terminals AI2 or AI3.

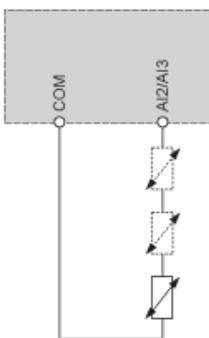

Sink / Source Switch Configuration

The switch is used to adapt the operation of the logic inputs to the technology of the programmable controller outputs.

- Set the switch to Source (factory setting) if using PLC outputs with PNP transistors.
- Set the switch to Ext if using PLC outputs with NPN transistors.

Switch Set to SRC (Source) Position Using the Output Power Supply for the Digital Inputs

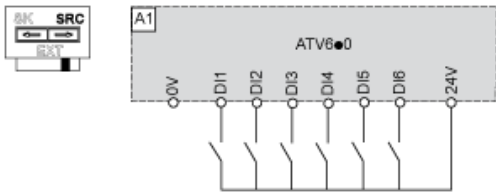

Switch Set to SRC (Source) Position and Use of an External Power Supply for the DIs

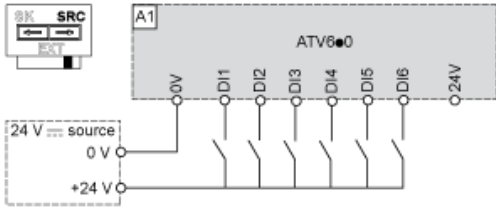

Switch Set to SK (Sink) Position Using the Output Power Supply for the Digital Inputs

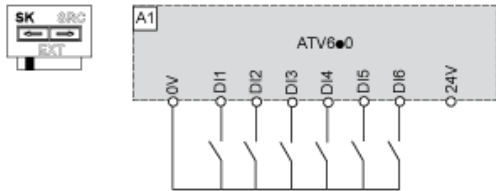

Switch Set to EXT Position Using an External Power Supply for the DIs

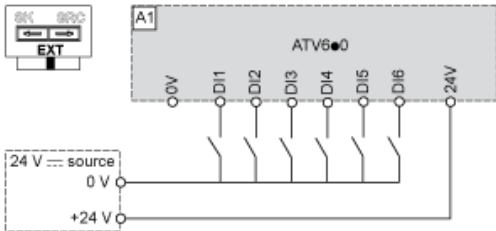

Derating Curves

